

## SONATEST ULTRASONIC PROBE DATASHEET

### SINGLE CRYSTAL DIRECT CONTACT COMPRESSION WAVE PROBE

Probe type: STARC2-15

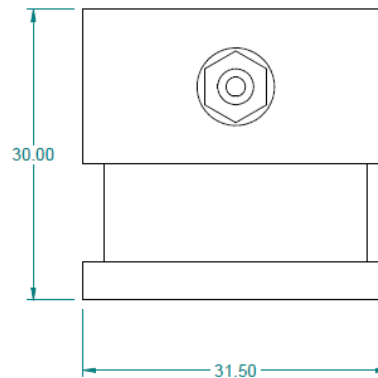

	STARC2-15
<b>BEAM ANGLE</b>	0°
<b>FREQUENCY</b>	2MHz ± 10%
<b>PULSE LENGTH</b>	1.3µsec ± 10%
<b>CRYSTAL SIZE</b>	Ø15mm disc
<b>CRYSTAL MATERIAL</b>	Lead Zirconate Titanate
<b>CASE MATERIAL</b>	Stainless Steel
<b>DEAD ZONE</b>	8mm
<b>NEAR FIELD</b>	21mm ± 20%
<b>DIVERGENCE</b>	3°±1°
<b>REFERENCE DB</b>	15dB

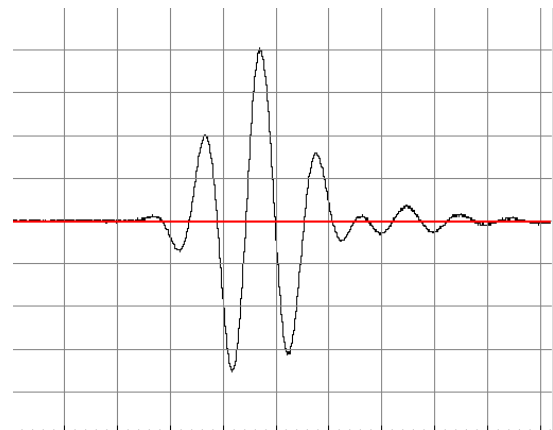

<b>MAXIMUM ALLOWABLE WEAR</b>	2.0 mm
<b>RECOMMENDED CABLE</b>	PC/L/ML or PC/L/S
<b>CONNECTOR TYPE</b>	LEMO 00 or SUBVIS

Sonatest Limited probes are manufactured to the highest standards for quality, reliability and performance within our registered quality system. Each probe is individually serialised and tested to the latest industry standard.