

SONATEST ULTRASONIC PROBE DATASHEET

SINGLE CRYSTAL ANGLE BEAM DIRECT CONTACT SHEAR WAVE PROBE

Probe type: STARC2-70

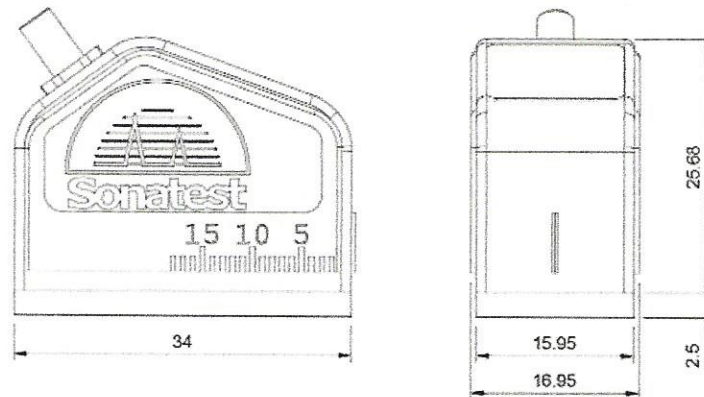

	STARC2-70
BEAM ANGLE	70°±2°
FREQUENCY	2MHz ± 10%
PULSE LENGTH	1.0µsec ± 10%
CRYSTAL SIZE	Ø10mm disc
CRYSTAL MATERIAL	Lead Zirconate Titanate
CASE MATERIAL	Stainless Steel
DEAD ZONE	10mm
NEAR FIELD	6mm ± 20%
DIVERGENCE	3°±1°
REFERENCE DB	29

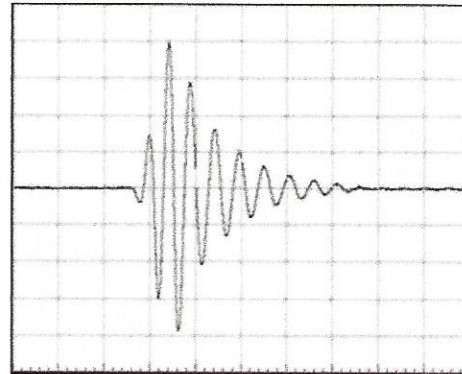

MAXIMUM ALLOWABLE WEAR	2.0 mm
RECOMMENDED CABLE	PC/L/ML or PC/L/S
CONNECTOR TYPE	LEMO 00 or SUBVIS

Sonatest Limited probes are manufactured to the highest standards for quality, reliability and performance within our registered quality system. Each probe is individually serialised and tested to the latest industry standard.