

SONATEST ULTRASONIC PROBE DATASHEET

SINGLE CRYSTAL DIRECT CONTACT COMPRESSION WAVE PROBE

Probe type: STARC4-15

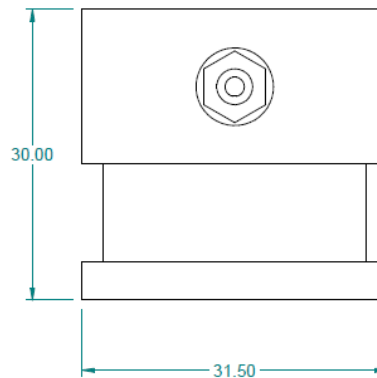

	STARC4-15
BEAM ANGLE	0°
FREQUENCY	4MHz ± 10%
PULSE LENGTH	1.0µsec ± 10%
CRYSTAL SIZE	Ø15mm disc
CRYSTAL MATERIAL	Lead Zirconate Titanate
CASE MATERIAL	Stainless Steel
DEAD ZONE	8mm
NEAR FIELD	38mm ± 20%
DIVERGENCE	3°±1°
REFERENCE DB	15dB

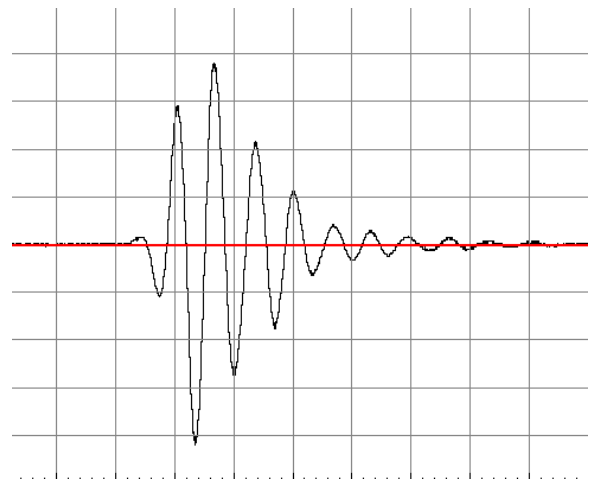

MAXIMUM ALLOWABLE WEAR	2.0 mm
RECOMMENDED CABLE	PC/L/ML or PC/L/S
CONNECTOR TYPE	LEMO 00 or SUBVIS

Sonatest Limited probes are manufactured to the highest standards for quality, reliability and performance within our registered quality system. Each probe is individually serialised and tested to the latest industry standard.